YAMAHA[®] LSI

YM2413

OPLL (FM OPERATOR TYPE-LL)

■ OUTLINE

This LL-Type FM Operator incorporates a DA Converter and a Quartz Oscillator in addition to a YAMAHA original FM Sound Generator, allowing for a much easier and economical sound generating system assembly than conventional LSIs. Tone data are stored in ROM for software simplicity, making it possible to execute data alterations involved in tone changes with just one Instruments selection operation. Furthermore, a built-in Tone Data Register with capacity for one tone permits sound effects and original tones generation. Tones applicable to the "CAPTAIN" and TELETEXT are included among built-in tone data.

■ FEATURES

- FM Sound Generator for real sound creation.
- Two selectable modes: 9 simultaneous sounds or 6 melody sounds plus 5 rhythm sounds (different tones can be used together in either case).
- Built-in Instruments data (15 melody tones, 5 rhythm tones, "CAPTAIN" and TELETEXT applicable tones).
- Built-in DA Converter.
- Built-in Quartz Oscillator.
- Built-in Vibrato Oscillator/AM Oscillator.
- TTL Compatible Input.
- Si-Gate NMOS LSI.
- A single 5V power source.

YAMAHA CORPORATION

YM2413 CATALOG
CATALOG No.: LSI-212413A2
1996. 6

Scanned and converted to PDF by HansO, 2001

■ PIN ASSIGNMENT

● YM2413

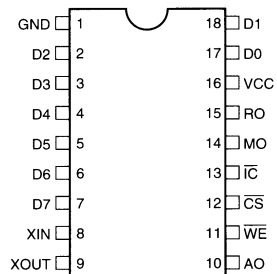

18 pin DIP Top View

● YM2413-F

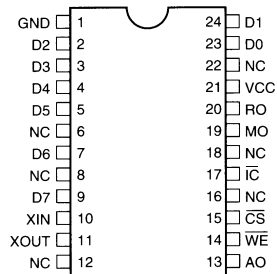

24 pin SOP Top View

■ BLOCK DIAGRAM

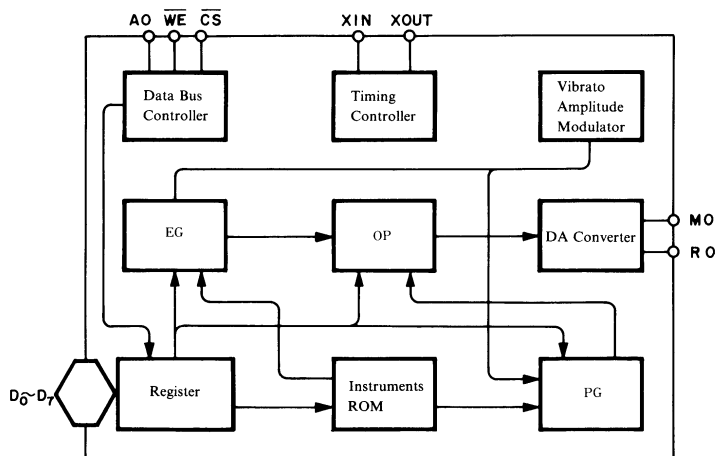

■ PIN FUNCTIONS

SYMBOL	I/O	FUNCTION	
XIN XOUT	I O	A quartz oscillator (3.579545 MHz) is connected between these two pins.	
D ₀ ⋮ D ₇	I/O	8-Bit Data Bus for OPLL control.	
A ₀ CS WE	I	For controlling the D ₀ ~D ₇ Data Bus.	
		CS WE A ₀	
		0 0 0	Writes register address into OPLL.
		0 0 1	Writes register contents into OPLL.
		0 1 0	Outputs OPLL test data to D ₀ /D ₁ Pins. Normally not used.
		0 1 1	OPLL Data Bus high impedance
		0 x x	
IC	I	Resets the system when level is low, clearing OPLL Registers.	
MO RO	O	Melody (MO) and Rhythm (RO) Outputs. Both sound types are output by a source follower. Integrated circuitry and an amplifier are necessary for subsequent processing.	
V _{cc}	I	+5V Power Pin.	
GND	—	Ground Pin.	

Note: Please do not connect NC.

■ EXPLANATION OF FUNCTIONS

This OPLL is a FM Sound Generator LSI with a built-in 9-Bit DA Converter. It has two sound generation modes: 9 melody sounds or 6 melody sounds plus 5 rhythm sounds, both allowing for simultaneous generation of different tones. Selection between these two modes can be performed from the software. One of the special features of this LSI is its built-in Instruments ROM. As shown in the table hereunder, this ROM incorporates 15 melody tones and 5 rhythm tones, as well as all tones used for "CAPTAIN" and TELETEXT for easy application to "CAPTAIN" Adaptors and Character Multiplex TVs. Furthermore, a built-in Tone Register with capacity for one tone allows for sound effects and original sounds creation. By controlling the parameters of this register (E, w₁, I and w₂ in the equation below), all kinds of harmonic can be created on the basis of the sample wave w₁.

$$FM = E \sin (w_1 t + I \sin w_2 t)$$

Unlike conventional FM sound generators, this OPLL has a built-in Instruments ROM, permitting a substantial simplification of sound generation commands from the processor. First, the desired Instruments code is stored in the Instruments Selection Register. Then, after data has been input at the fixed intervals and timing, the unit starts generating sound. Processor automatic play can be easily performed by writing data appropriate to the music into the Sustain and Volume Registers. For using an original tone, the Instruments Selection Register must be cleared after writing data into the Tone Register as explained above. Rhythm sounds are generated by turning ON or OFF the corresponding bits in the Rhythm Control Register. In this case, the specified data must be input to the Key ON/OFF and F-Number Registers 8CH and 9CH.

■ REGISTER MAP

Address	D ₇	D ₆	D ₅	D ₄	D ₃	D ₂	D ₁	D ₀		
00	A	V	E	K	MULTI					User Tone Register
01	M	I	G	S						
02	KSL		T		L ₈					
03	DC		DM	F B						
04	A R			D R						
05	S L			R R						
06	S L			R R						
07	S L			R R						
0E	R		BD	SD	TOM	TCT	HH		Rhythm Control	
0F	T E S T								OPLL Test Data	
10	F-Num.0 ~ 7								F-Number LSB 8 bits	
11	F-Num.0 ~ 7									
18	F-Num.0 ~ 7									
20	S		K	BLOCK			F		F-Number MSB, Octave set	
21	U		E	0 ~ 2			N		Key ON/OFF Register	
22	S		Y				u		Sustain ON/OFF Register	
28	ON		ON				m			
29	OFF		OFF				8			
30	INST.				VOL.				Instruments Selection and Volume Register	
31	INST.				VOL.					
38	INST.				VOL.					

Register Contents

	Address	Bit	
1	00, 01	D7	Amplitude modulation ON/OFF switch
		D6	Vibrato ON/OFF switch
		D5	Sustained sound/decaying sound switch. 0: decaying sound 1: sustained sound
		D4	RATE key scale
		D0~D3	Controls MULTI sample wave - harmonics relationship
2	02, 03	D6 D7	LEVEL key scale
3	02	D0~D5	Modulated wave total level. Modulation index control
4	03	D3 D4	Carrier and modulated wave distortion waveform (flat wave rectification) ON/OFF switch
		D0~D2	FM feedback constant
5	04, 05	D4~D7	Attack envelope change rate control
		D0~D3	Decay envelope change rate control
6	06, 07	D4~D7	Indication of decay - sustain level
		D0~D3	Release envelope change rate control
7	0E	D5	Rhythm sound mode selection. 1: Rhythm sound mode 0: Melody sound mode
		D0~D4	Rhythm instruments ON/OFF switch
8	10~18	D0~D7	F-Number LSB 8 bits
9	20~28	D5	Sustain ON/OFF switch
		D4	Key ON/OFF
		D1~D3	Octave setting
		D0	F-Number MSB
10	30~38	D4~D7	Instruments selection
		D0~D3	Volume data

Tone Data

	Instrument		Instrument
0	Original	8	Organ
1	Violin	9	Horn
2	Guitar	10	Synthesizer
3	Piano	11	Harpsichord
4	Flute	12	Vibraphone
5	Clarinet	13	Synthesizer Bass
6	Oboe	14	Acoustic Bass
7	Trumpet	15	Electric Guitar

Envelope Waveforms

Decaying Sounds

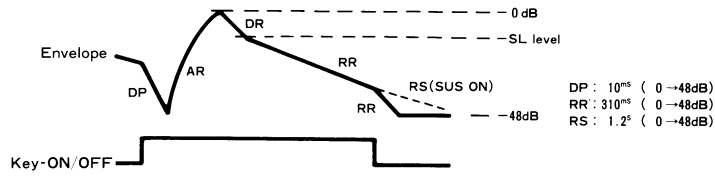

Sustained Sounds

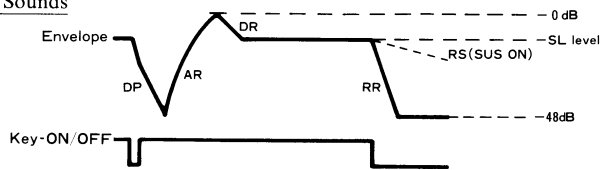

■ TIMING DIAGRAMS (Standard timing settings are V_{IH} = 2.0V, V_{IL} = 0.8V)

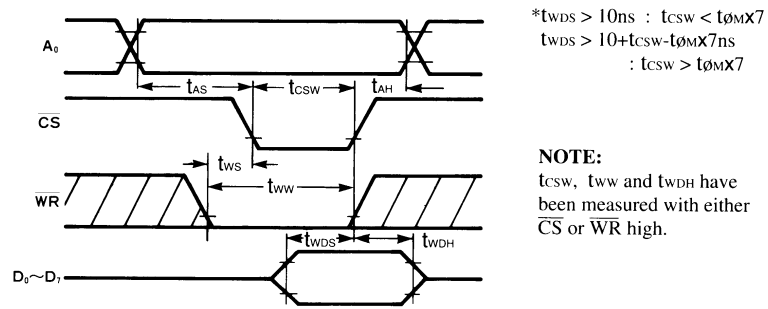

Fig. A-1 Write Timing

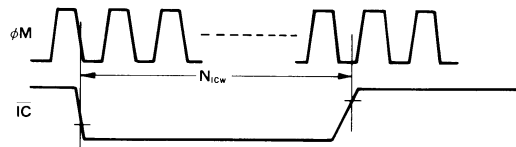

Fig. A-2 Reset Timing

■ ELECTRICAL CHARACTERISTICS

1. Absolute Maximum Ratings

ITEM	RATING	UNIT
Pin voltage	0.3~7.0	V
Ambient operating temperature	0~70	°C
Storage temperature	-50~125	°C

2. Recommended Operating Conditions

ITEM	SYMBOL	MIN.	TYP.	MAX.	UNIT
Supply voltage	V _{CC}	4.75	5	5.25	V
	GND	0	0	0	V

3. DC Characteristics

ITEM	SYMBOL	CONDITION	MIN.	TYP.	MAX.	UNIT
High level input voltage	All input	V _{IH}	2.0			V
Low level input voltage	All input	V _{IL}			0.8	V
Leak input current	A0, \overline{WE}	I _L	V _{in} = 0~5 V	-10	10	μA
Three-state (off) Input current	D ₀ ~D ₇	I _{TSL}	V _{in} = 0~5 V	-10	10	μA
Analog output voltage	MO	V _{MOA}	R _{LOAD} = 2.2Ω peak to peak		1.6	V
	RO	V _{ROA}	R _{LOAD} = 2.2Ω peak to peak		1.6	V
Pullup resistance	\overline{IC} , \overline{CS}	R _U		100		kΩ
Input capacity	All input	C _I			10	pF
Output capacity	All input	C _O			10	pF
Power current		I _{CC}		40	80	mA

4. AC Characteristics

ITEM	SYMBOL	CONDITION	MIN.	TYP.	MAX.	UNIT
Address setup time	A ₀	t _{AS}	Fig. A-1	10		ns
Address hold time	A ₀	t _{AH}	Fig. A-1	10		ns
Chip select write width	\overline{CS}	t _{CSW}	Fig. A-1	80		ns
Write pulse write width	\overline{WE}	t _{WW}	Fig. A-1	110		ns
Write pulse set up	\overline{WE}	t _{WS}	Fig. A-1	30		ns
Write data setup time	D ₀ ~D ₇	t _{WDS} *	Fig. A-1	10		ns
Write data hold time	D ₀ ~D ₇	t _{WDH}	Fig. A-1	25		ns
Reset pulse width	\overline{IC}	N _{ICW}	Fig. A-2		80	cycle

■ OUTLINE DIMENSIONS

YM2413

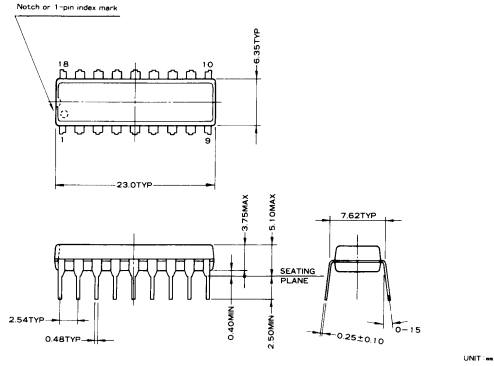

YM2413-F

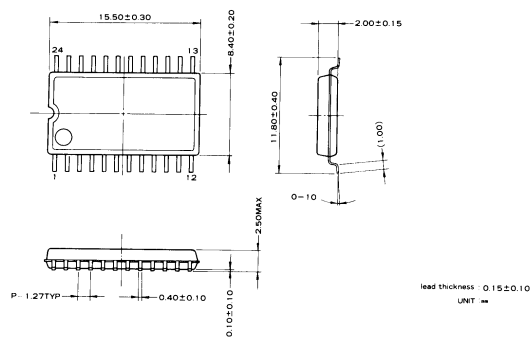

Note : The LSIs for surface mount need especial consideration on storage and soldering conditions. For detailed information, please contact your nearest agent of yamaha.